

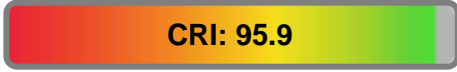

Light efficiency:



Light quality:



Color temperature:

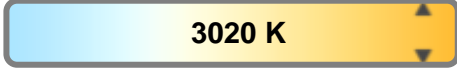

Output: 4684 lm
Peak: 11939 cd
Power: 135 W
PF: 0.99



Beam angle **38.9°**

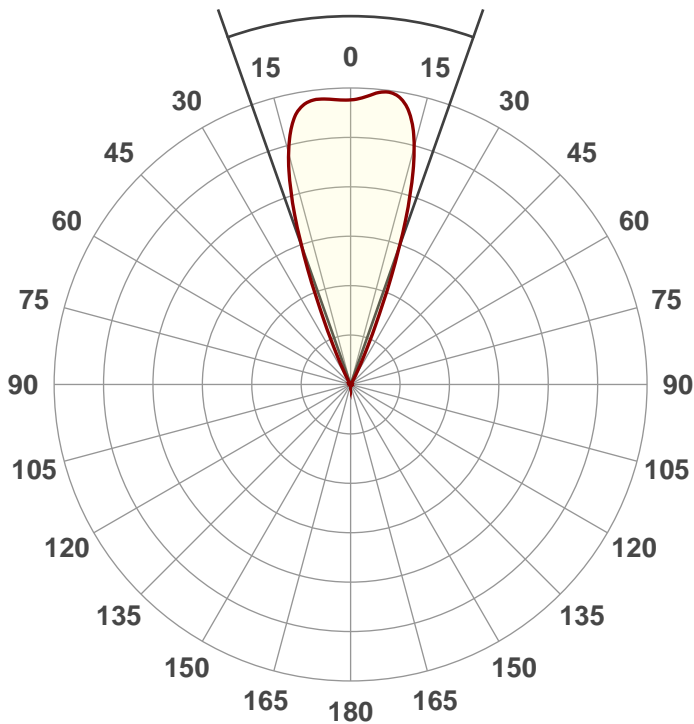

CIE 1931
x: 0.435
y: 0.403

Product name:
Encore FR150Z
Item number:
Zoom Out
Date:
10/9/2017
Description:

Spectra

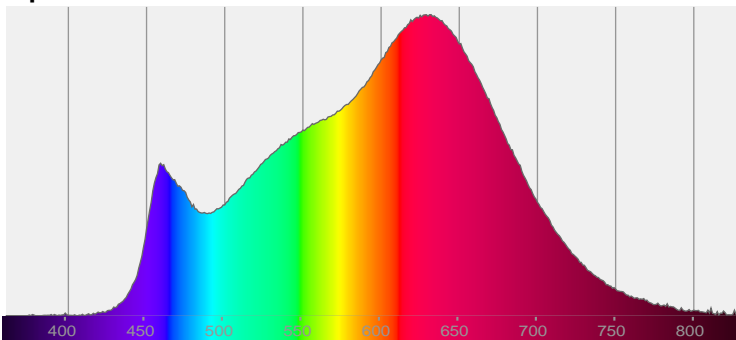

Power

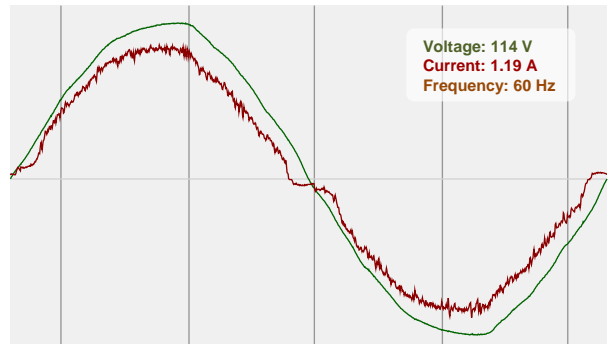

Color details

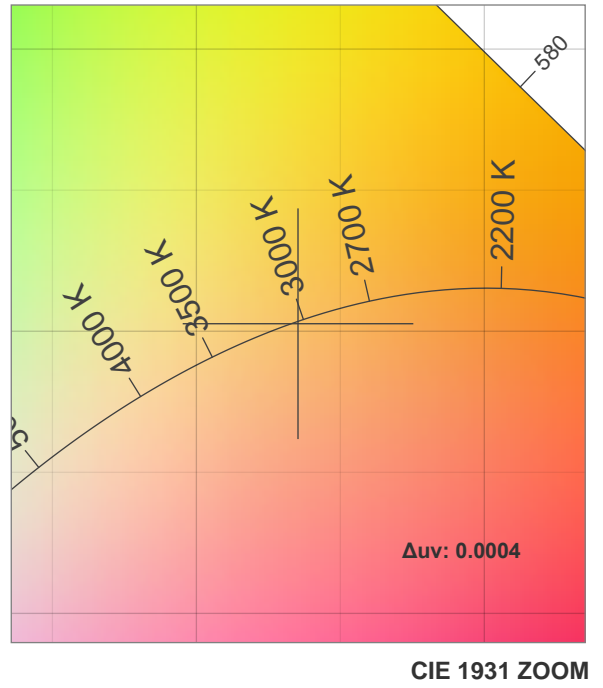
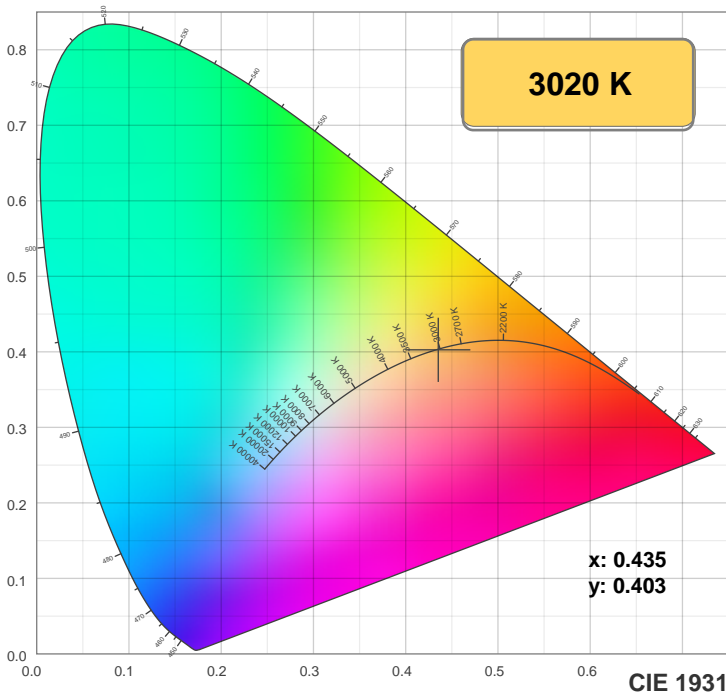

TM30: 88.6

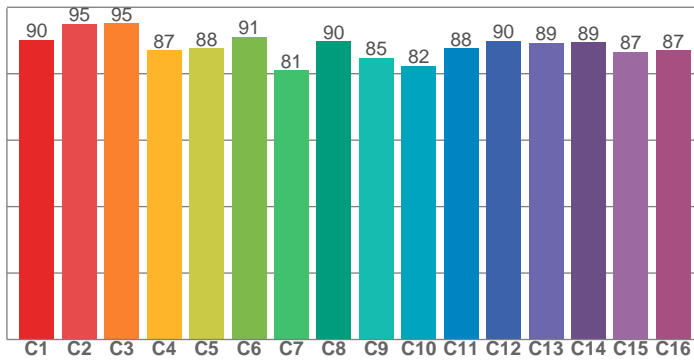

CRI: 95.9 (R1-R8)

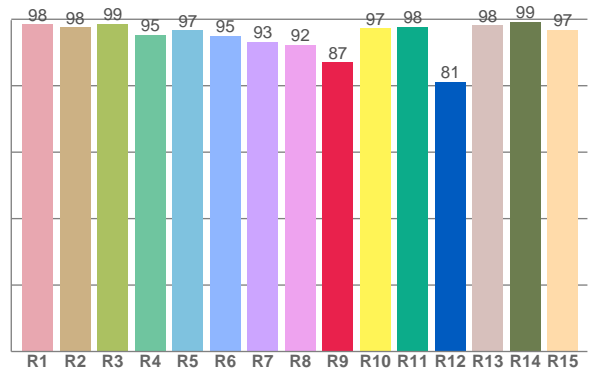

CRI R values, only R1-R8 are used to calculate final CRI value

R1	R2	R3	R4	R5	R6	R7	R8	R9	R10	R11	R12	R13	R14	R15
98.5	97.6	98.6	95.3	96.7	95.1	93.3	92.3	87.2	97.2	97.8	81.2	98.2	99.3	96.8

TM30 C values, 16 binned values out of total of 99 C values

C1	C2	C3	C4	C5	C6	C7	C8	C9	C10	C11	C12	C13	C14	C15	C16
90.2	95.0	95.2	87.0	87.6	91.1	81.0	89.7	84.7	82.4	87.6	89.8	89.4	89.5	86.6	87.0

CQS Q values

Q1	Q2	Q3	Q4	Q5	Q6	Q7	Q8	Q9	Q10	Q11	Q12	Q13	Q14	Q15
87.0	92.6	95.2	91.2	89.5	89.3	94.8	96.1	95.0	95.4	98.1	98.1	97.8	94.3	91.7

CQS: 92.7

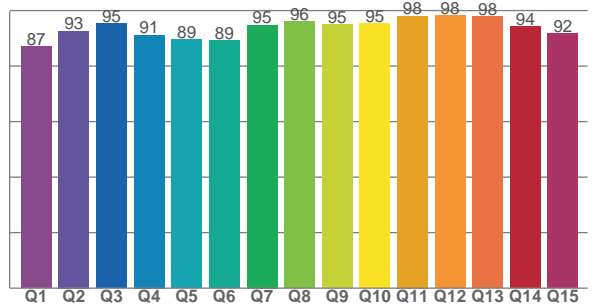

Color parameters

Color temperature	Color rendering index	Red component	Color fidelity	Color gamut	Color quality scale	Color coordinate cie 1931	Color coordinate cie 1931	Color coordinate	Color coordinate	Color deviation from black body
CCT	CRI	CRI R9	TM30 Rf	TM30 Rg	CQS	x	y	u	v	Δuv
3020 K	95.9	87.2	88.6	96.3	92.7	0.435	0.403	0.250	0.347	0.0004

Beam details

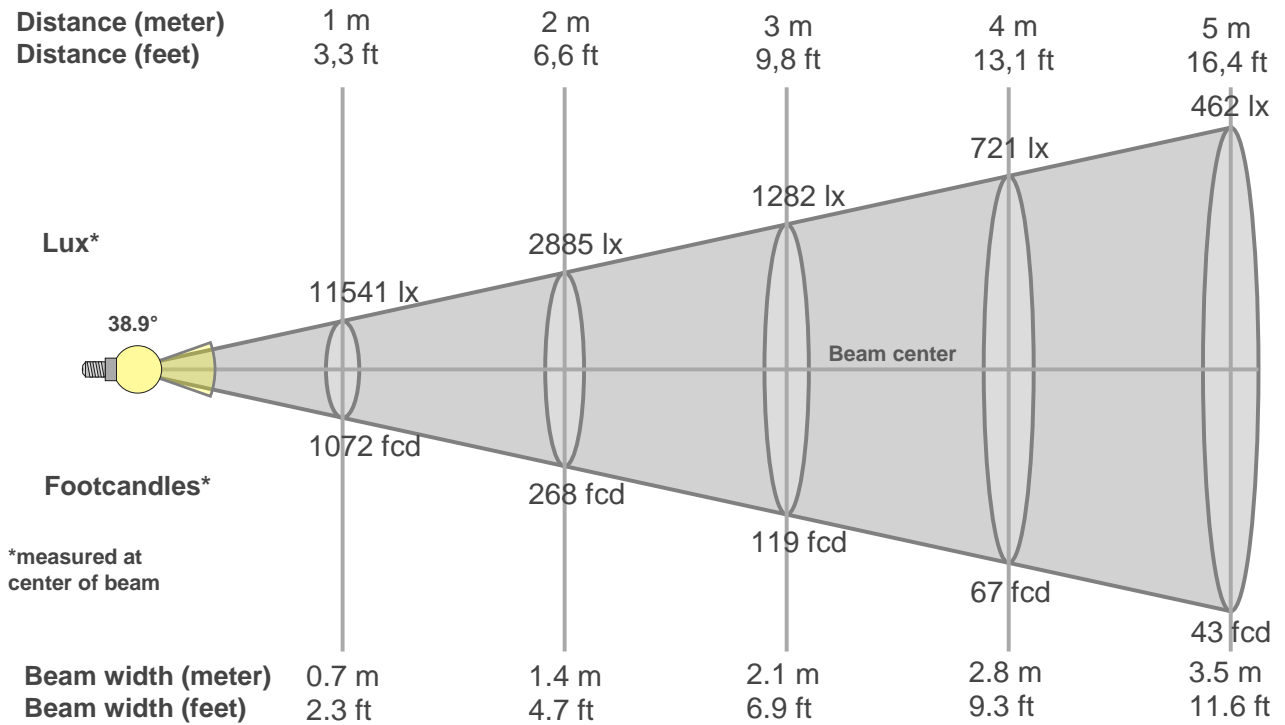

Beam intensities from 1-20m

1m	2m	3m	4m	5m	6m	7m	8m	9m	10m	11m	12m	13m	14m	15m	16m	17m	18m	19m	20m
3.3ft	6.6ft	9.8ft	13.1ft	16.4ft	19.7ft	23ft	26.2ft	29.5ft	32.8ft	36.1ft	39.4ft	42.7ft	45.9ft	49.2ft	52.5ft	55.8ft	59.1ft	62.3ft	65.6ft
11541lx	2885lx	1282lx	721lx	462lx	321lx	236lx	180lx	142lx	115lx	95lx	80lx	68lx	59lx	51lx	45lx	40lx	36lx	32lx	29lx
1072.2fcd	268.1fcd	119.1fcd	67fcd	42.9fcd	29.8fcd	21.9fcd	16.8fcd	13.2fcd	10.7fcd	8.9fcd	7.4fcd	6.3fcd	5.5fcd	4.8fcd	4.2fcd	3.7fcd	3.3fcd	3fcd	2.7fcd

Intensities in 0° c-plane

0°	2°	4°	6°	8°	10°	12°	14°	16°	18°	20°	22°	24°	26°	28°	30°	32°	34°	36°	38°
11.5K	11.5K	11.6K	11.6K	11.6K	11.4K	11.0K	10.2K	9.1K	7.4K	5.4K	3.4K	1.9K	1.0K	0.5K	0.3K	0.1K	0.1K	0.1K	0.1K
100%	100%	100%	101%	100%	99%	95%	89%	79%	64%	47%	29%	16%	8%	4%	2%	1%	1%	1%	0%

Intensities in 90° c-plane

0°	2°	4°	6°	8°	10°	12°	14°	16°	18°	20°	22°	24°	26°	28°	30°	32°	34°	36°	38°
11.5K	11.5K	11.6K	11.6K	11.6K	11.4K	11.0K	10.2K	9.1K	7.4K	5.4K	3.4K	1.9K	1.0K	0.5K	0.3K	0.1K	0.1K	0.1K	0.1K
100%	100%	100%	101%	100%	99%	95%	89%	79%	64%	47%	29%	16%	8%	4%	2%	1%	1%	1%	0%

Intensities in 180° c-plane

0°	2°	4°	6°	8°	10°	12°	14°	16°	18°	20°	22°	24°	26°	28°	30°	32°	34°	36°	38°
11.5K	11.6K	11.8K	11.9K	11.9K	11.7K	11.3K	10.5K	9.2K	7.5K	5.4K	3.4K	1.9K	1.0K	0.5K	0.3K	0.2K	0.1K	0.1K	0.1K
100%	101%	102%	103%	103%	102%	98%	91%	80%	65%	47%	29%	17%	9%	5%	2%	1%	1%	1%	0%

Intensities in 270° c-plane

0°	2°	4°	6°	8°	10°	12°	14°	16°	18°	20°	22°	24°	26°	28°	30°	32°	34°	36°	38°
11.5K	11.6K	11.8K	11.9K	11.9K	11.7K	11.3K	10.5K	9.2K	7.5K	5.4K	3.4K	1.9K	1.0K	0.5K	0.3K	0.2K	0.1K	0.1K	0.1K
100%	101%	102%	103%	103%	102%	98%	91%	80%	65%	47%	29%	17%	9%	5%	2%	1%	1%	1%	0%

Beam angle 50%	Field angle 10%	Cutoff angle 2,5%	Intensity ratio in 120° cone	Intensity ratio in 90° cone
38.9°	50.8°	59.2°	97.4%	96.9%